

## CEEC Vacuum Tanker Truck

# User's Manual



CEEC AUTO LIMITED

<http://www.ceetrucks.com>

Email: [info@ceetrucks.com](mailto:info@ceetrucks.com) [tom@ceetrucks.com](mailto:tom@ceetrucks.com)

# Vacuum Tank Truck



CEEC TRUCKS

Whatsapp: +86 136 4729 9000  
+86 159 7192 0800

## OWNER'S MANUAL

# Preface

Thank you for purchasing CEEC TRUCKS products. For better using your BEIBEN Vacuum Tanker Truck, get the best operating performance, we strongly suggest that before the operation process you should read this manual instructions carefully, and to manipulate the program handily.

The manual detailed describes the performance of vacuum sewage truck, structure, usage, precautions and maintenance of such knowledge. While showing details of the truck, both pictures and description will together help you get better understanding of how to use truck. Before the operation, the skilled operator should carefully read the contents of the manual.

After master the truck performance characteristics, methods of operation and precautions, then could start to operate this sewage suction truck. In order to ensure the staff turnover after the operation, and properly use of the truck. This manual book must be properly kept, shall not be lost and damage.

CEEC TRUCKS

Whatsapp: +86 136 4729 9000  
+86 159 7192 0800

---CEEC TRUCKS

# Contents

Chapter 1. General Description.....	5
Chapter 2, Main Technical Data.....	6
i , Vacuum Tanker Truck technical parameter.....	6
ii , Sewage trucks application notice.....	7
Chapter 3, Sewage Truck Structure Components.....	8
i , Sewage Truck Structure Components.....	8
Chapter 4, Vacuum Tanker Truck Working Principles.....	12
i , How are the sewage trucks working?.....	12
ii , What is the main component for truck?.....	12
iii, How to operate sewage trucks?.....	13
Chapter 5, Troubleshooting.....	18

## Chapter 1. General Description

CEEC TRUCKS Vacuum Tanker Truck based on type II BEIBEN 6\*4 Left Hand Drive chassis, capacity for sewage tank can be up to 10,000 liters, which also installed with best performed Chinese brand vacuum pump. The truck main consist of below system: PTO, Driving system, Combined Vacuum pump system, Durable vacuum tank system, High pressure working system, Pipeline system, Vacuum gauge, View window, Washing system, Clean water tank, etc.

The vehicle designed to fully rely on the advantages of the original of BEIBEN brand chassis, fully consider the product's convenience and reliability, also the chassis BEIBEN technology features. The vacuum tanker truck has advantage of big capacity and suction efficiently, and maintenance for whole truck can be easily. The tank material is international standard strength carbon steel, which treated with antirust painting both inside and outside.

The BEIBEN 6x4 Vacuum Tanker Truck is ideal and special-purpose machinery used for dredging city sewer, specially applied to pumping, cleaning and transporting the sewage sludge, also can be used for suction droppings and some other works. The truck is widely used for all kinds of suction work in city, high-way service station, airport, community, factory, etc. Therefore, the vehicle is an ideal Vacuum Truck mainly for liquid sewage suction.



(Preview for your BEIBEN Vacuum Tanker Truck)

## Chapter 2, Main Technical Data

### i ,Vacuum Tanker Truck technical parameter

Items		10,000 Liters BEIBEN Sewage Truck
S I Z E	Outer Dimension (L×W×H) (mm)	9000x2500x3200
	Wheelbase (mm)	4500+1350
Kerb Weight (kg)		11500
G E A R	Gearbox brand	FAST
	Model	9-shift gearbox
	Type	Manual
Cab capacity (includes driver)		2
E N G I N	Brand	WEICHAI
	Model	WP7.300E30
	Type	Six cylinder inline, four stroke, water-cool, turbocharged Inter-cooling, diesel
	Rating Power (kW/HP)	220 / 300

Note: 1.The vehicle height includes top overflow valve.

2. We keep the right to revise the parameters on the list above.

Whatsapp: +86 136 4729 9000

Sewage Suction System basic parameter list 86 158 7192 0800

Items		Parameter
Superstructure	Dirty water tank	10000 Liters
	Material	Carbon steel, 6mm thick
	Design pressure	Full Vacuum—0.9bar
	Vacuum pump	China famous WEILONG
	Suction Pipeline	PVC hose with 4" diameter
	Full-suction time	≤5min
	Discharge valve	6" discharge valves
	Rear cover	Hydraulic open and Manual locking

## ii ,Sewage trucks application notice

(1) *Keep the vacuum pump at suitable revolution speed:*

*If the pump too speedy, the rotor's temperature will be very high; on the contrary, the pump too slowly, engine knock will happen, which will impact the parts and affect the service life. In one word, the proper revolution speed is necessary, and should have the HAND THROTTLE to the largest adjustment position in advance.*

(2) *Rollover the tanker on flat road*

*Rollover the tanker on the tilt road will not only make parts distortion and lead to malfunction, but also an accident.*

(3) *Open rear door before rollover the tanker*

*Open rear door before rollover the tanker is very important, or there may be an accident.*

(4) *When clutch pump and vacuum pump take power form PTO, have the engine idling, and completely press the clutch pedal, then slowly lift the clutch pedal.*

(5) *NOTES: Keep the PTO box's joysticks in middle position while driving.*

(6) *Waste oil and other danger things are not allowed to be carried by this vehicle.*

(7) *The supporting rods and safety stop must be used while tanker is raising position before entering the base or repairing the tanker.*

*Whatsapp: +86 136 4729 9000*

*+86 159 7192 0800*

(8) *When transporting sewage, the manual rear door clamping device must be used to keep safety. For there are no water cutter and the high barycenter, the vehicle also must drive at middle or low speed, and must not turning and braking suddenly.*

## Chapter 3, Sewage Truck Structure Components

### i ,Sewage Truck Structure Components

Overview for BEIBEN Vacuum sewage truck technical drawing:

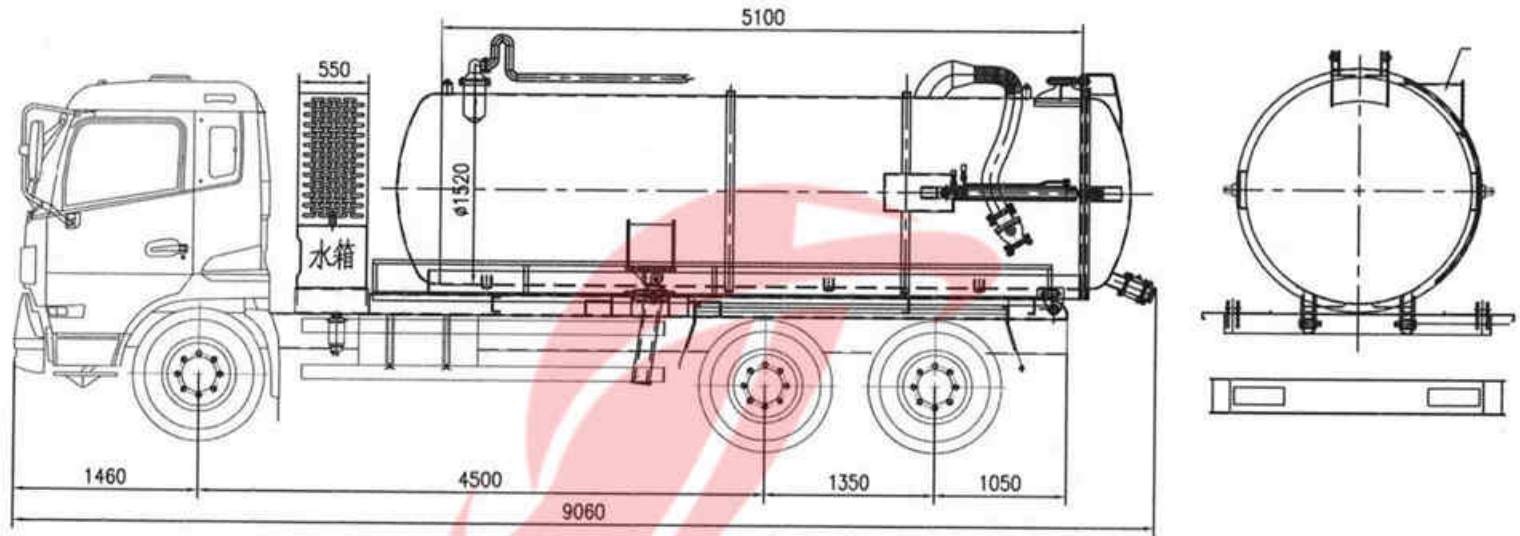

MAIN PARTS: 1, air operated valve

2, PTO box joysticks

3, vacuum pump

4, manual operated valve

5, four-way valve

6, oil-gas separator

7, rollover oil tanker

8, suction valve

9, open-door cylinder

10, discharge valve

11, rear door clamping device

12, scupper valve

13, suction soft pipe

14, safety alarm

Whatsapp: +86 136 4729 9000  
+86 159 7192 0800

Above drawing show detailed parts for this BEIBEN vacuum tanker truck, which use original BEIBEN type 2 model 6x4 chassis, with white color cabin, wheelbase 4500+1350mm, WEICHAO diesel engine with 300PS, FAST 9-shift manual gearbox, detailed picture for chassis as below:



*Vacuum Pump: Combined two units famous Chinese brand WEILONG vacuum pump, which installed below of the tanker system*

Vacuum Pump System below of tanker (2 units pump connected)



*Manual Operated Valve: equipped at driver side of the platform, which control the vacuum tank rise / fall, and rear door open / close.*

Manual Operated Valve



Whatsapp: +86 136 4739 0900  
+86 159 7192 9890

Hydraulic Cylinder (2 units)

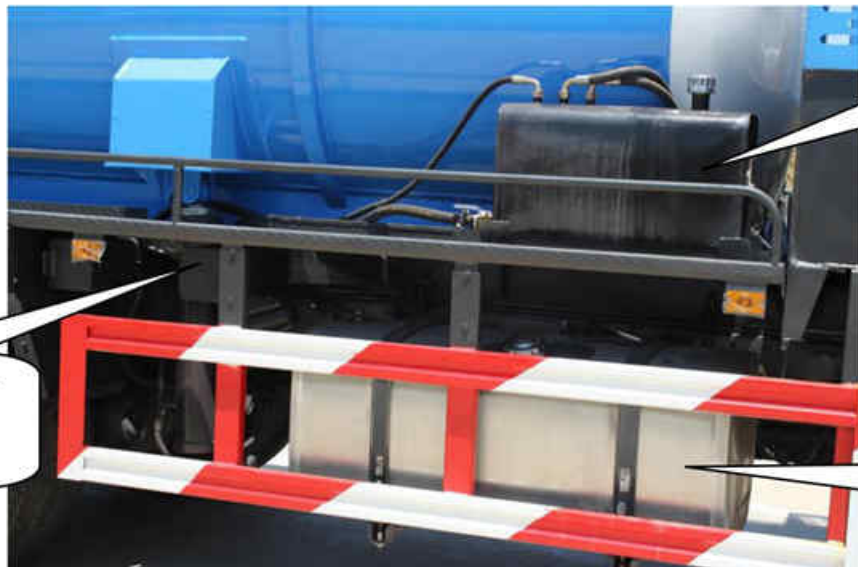

Hydraulic Oil Tanker

Truck fuel tanker

Vacuum System: equipped with Four-Way Valve, First Level Oil-Gas Separator, Second Level Oil-Gas Separator, Water-Gas Separator. *(Combined Vacuum Pump System)*

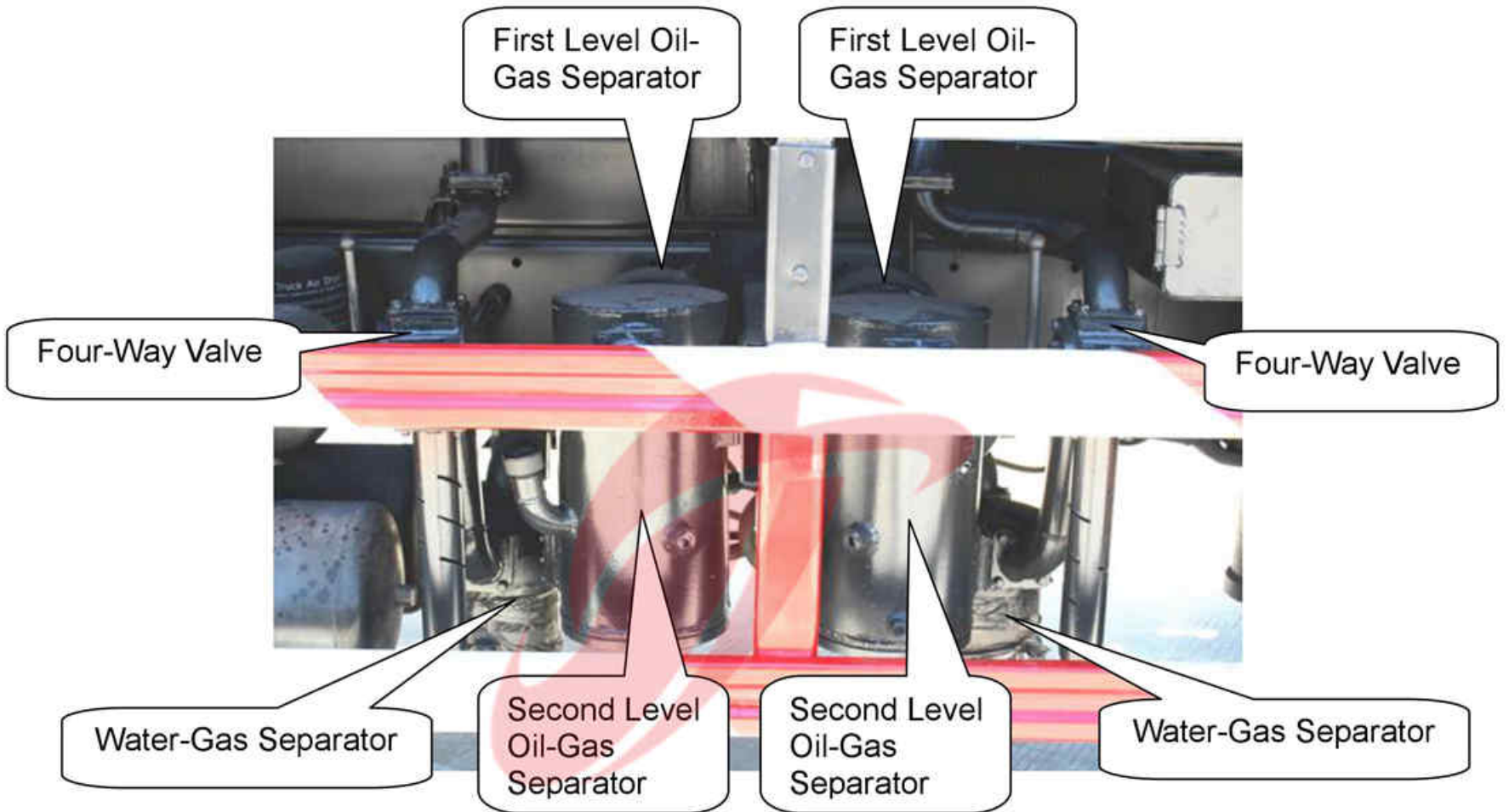

CEEC TRUCKS

Whatsapp: +86 136 4729 9000  
+86 159 7192 0800

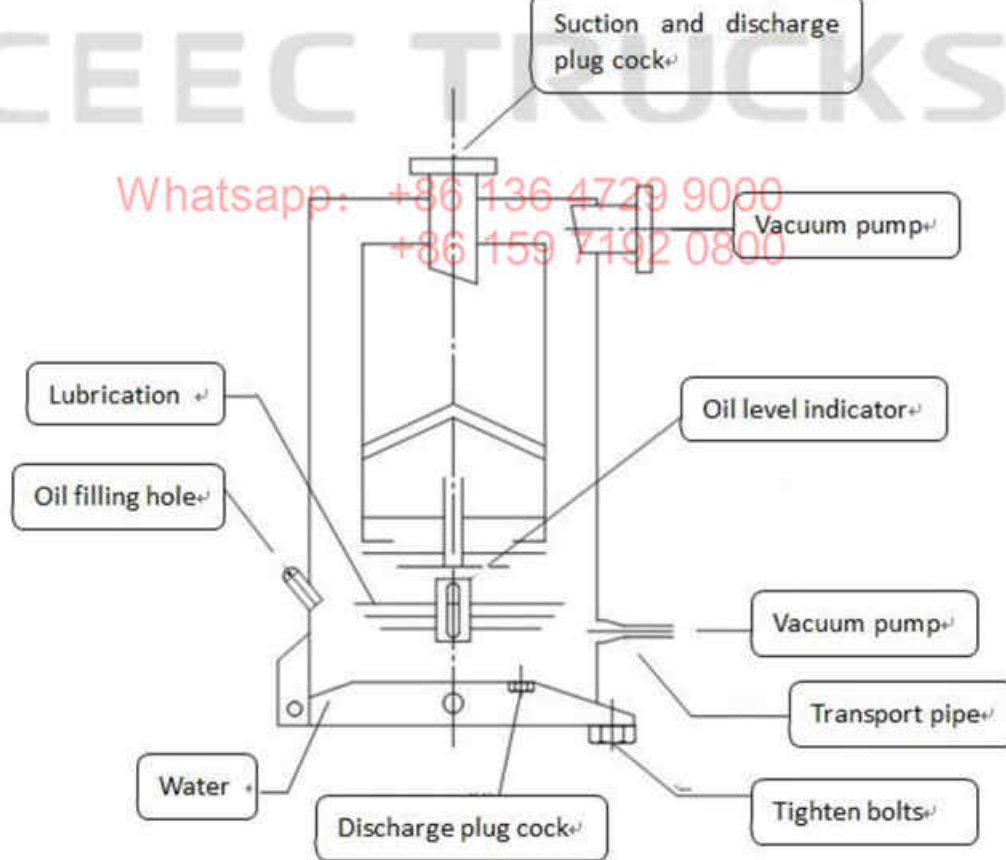

*(Second Level Oil-Gas Separator)*

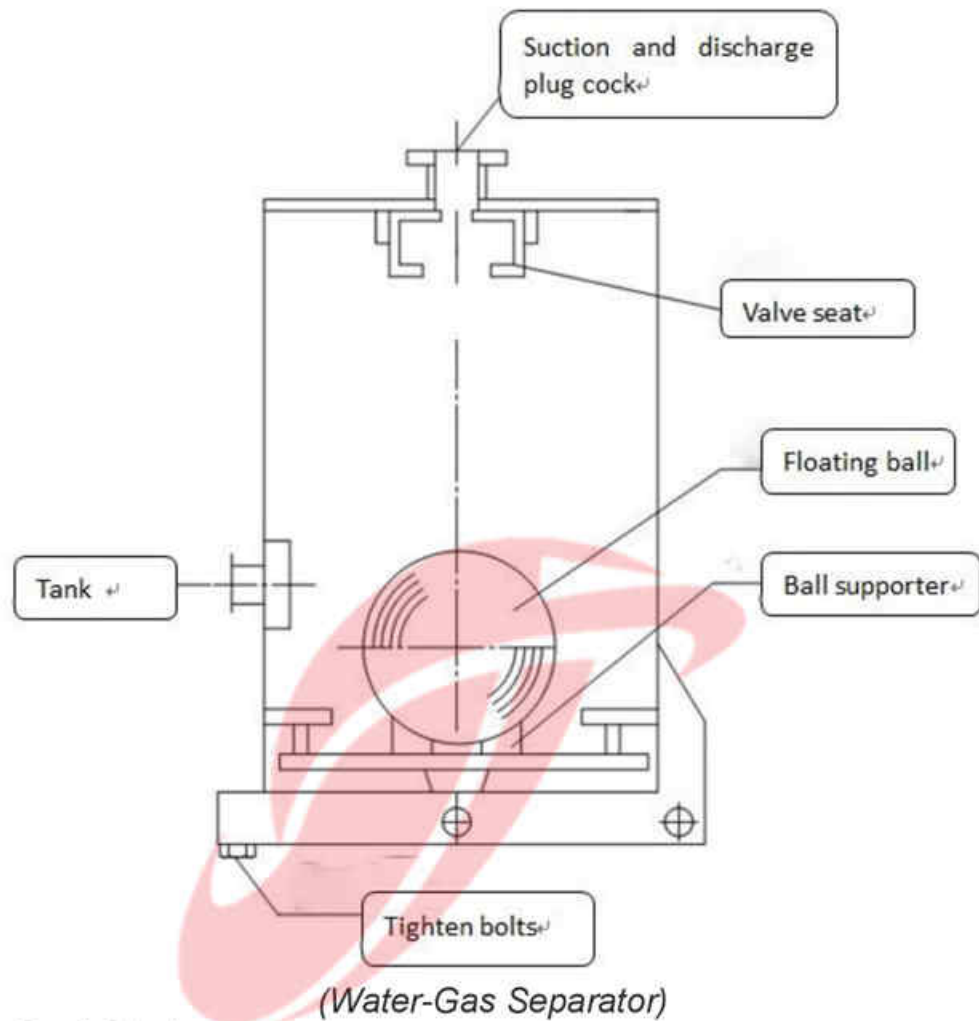

Whole view of the Truck Tanker:

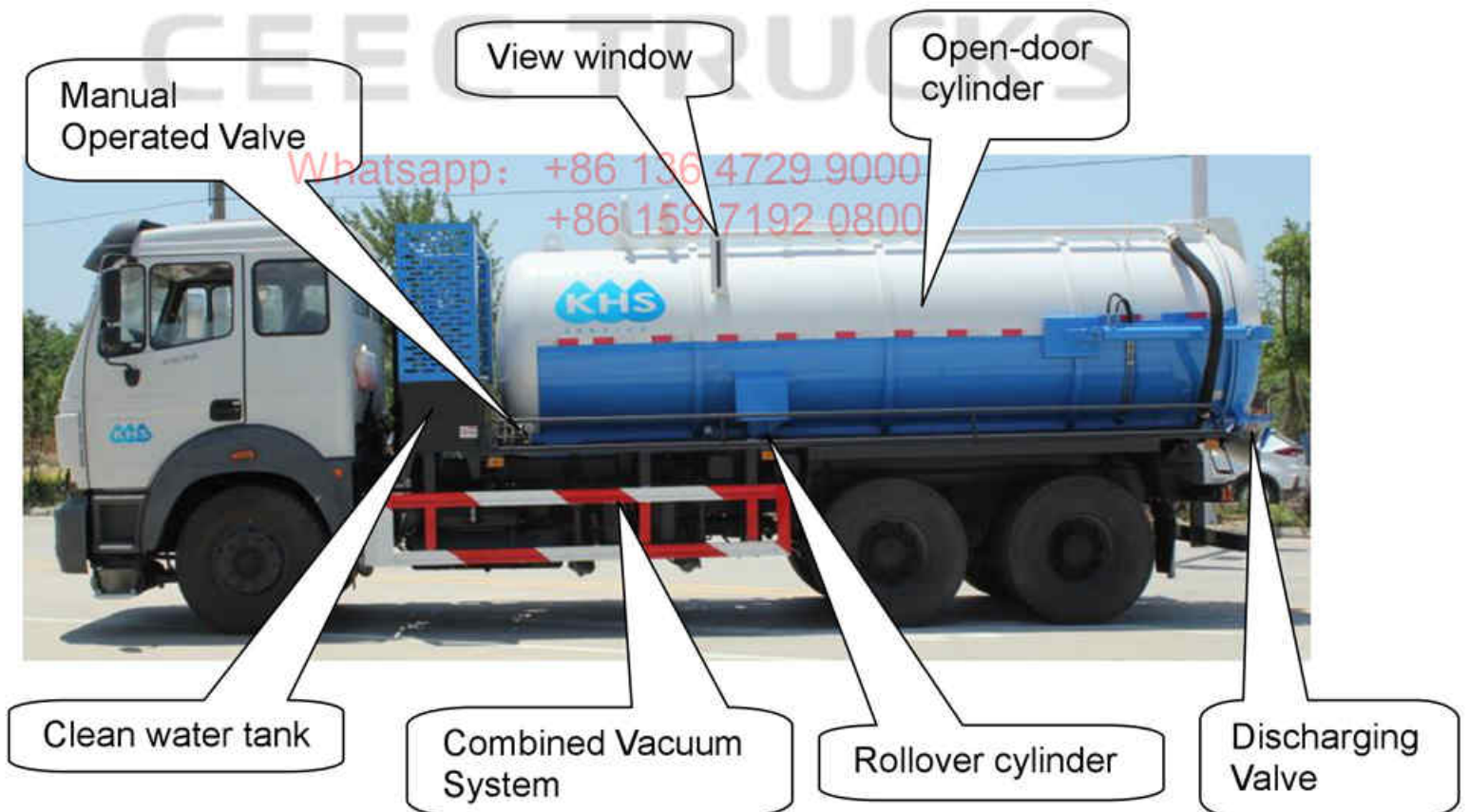

## Chapter 4, Vacuum Tanker Truck Working Principles

*The operator should fully understand Whole Structure and Working Principle for BEIBEN Vacuum Sewage Truck before any operation. Only trained person can operate this vehicle properly and to prevent unnecessary accidents and equipment damage.*

### **i ,How are the sewage trucks working?**

*The BEIBEN Sewage Truck makes use of the PTO to get the power from truck engine, and the power drive the vacuum system working. Operation the valves to control the truck suction liquid sewage, adjust the throttle knob to make suction speed faster and slowly. After suction working, using Manual Operated Valves to control rear door Open/Close, and sewage tanker Rise/Fall. After working, cleaning the sewage tank, and ready for next time operation.*

### **ii ,What is the main component for truck?**

*The sewage truck is refitted based on the BEIBEN 6x4 LHD chassis. The refit part includes Vacuum suction assembly, actuator device and operation system.*

- *Vacuum suction assembly: One round shape vacuum sewage tank. 1 unit suction pipeline, Combined double vacuum suction system.*
- *Actuator device: includes PTO, drive line, etc., which can pass the power to the pump.*
- *Operation system: helps come to all special functions' convert.*

### iii, How to operate sewage trucks?

#### (1) Suction operation preparation

A, Keep the sewage tank rear door closed

B, Carefully check whether the lubrication of vacuum pump gas-oil separator working normally.



#### (2) Operations sequence (Detail figure)

A, Press the clutch pedal, **pull out the PTO switch together**, to get power from the truck engine and start the vacuum pump, then slowly release the pedal.

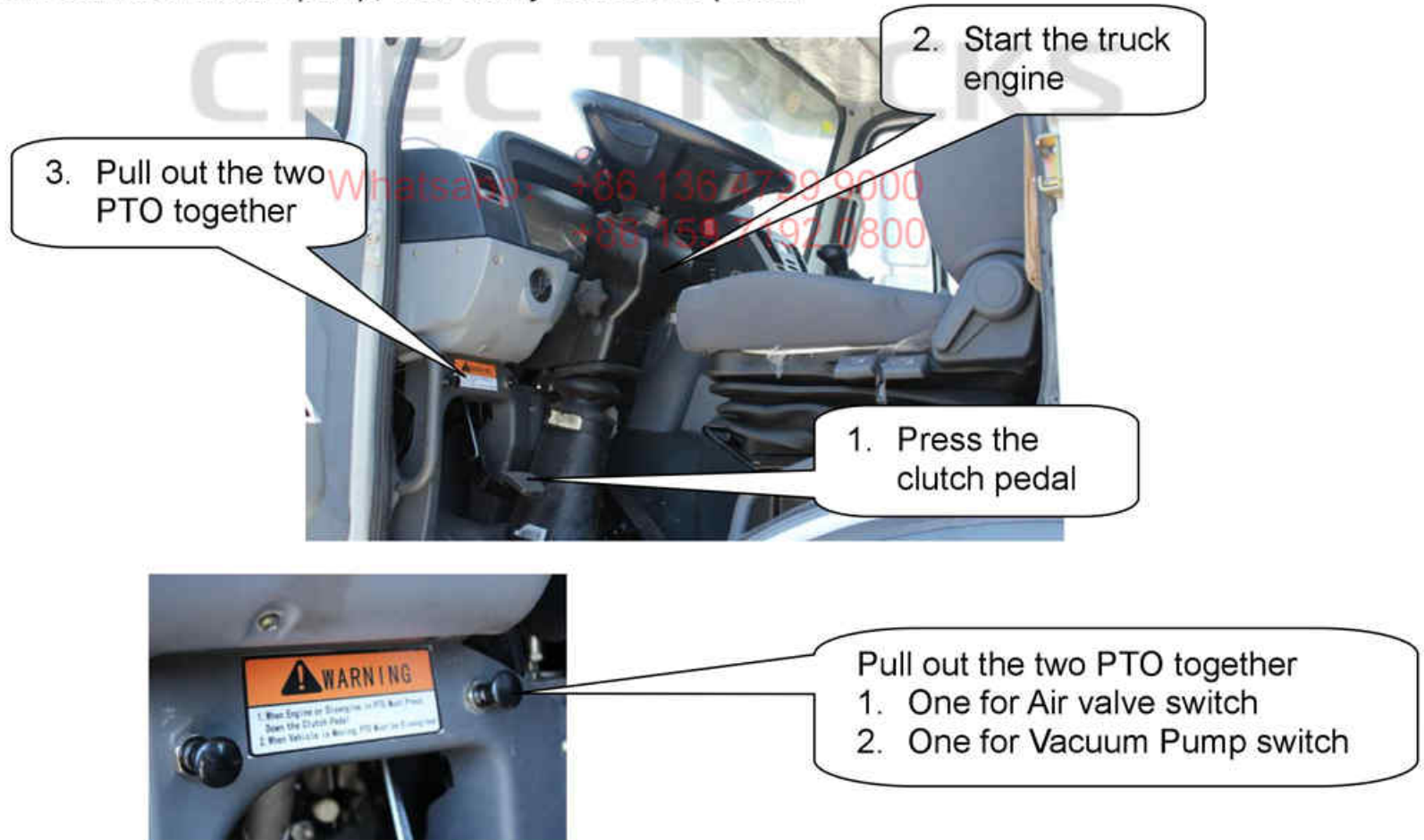

B, Start the safety alarm (in the cab)

C, Keep the revolution meter point to 500-600r/min (already has been set before out the factory)

D, Adjust the four-way valve joystick to suction position, carefully check the released air, the vacuum pump sound, the vacuum meter.



Suction Position



Neutral Position

E, Put the suction pipe into the sewage. Park the vehicle in right place before suction working, which can keep the pipe straight or free bending state, and guarantee vehicle work normally.



Suction Pipeline:  
One head connect with this valve  
One head into the sewage pool

(3) Attention while working

A, Things like over 50mm stone, cotton yarn, leaves etc. will block the suction pipe, and should not be suction, also should keep the pipe clean and unblocked.

B, Keep the suction valve full open while vacuum meter point to 65-80kpa, because half-open may damage the valve.

C, The suction pipe should be moved frequently while suction. Because suction some air and water will increase efficiency when the sewage is too viscosity.

### 3, Waste water discharge operating instruction.

After sludge and waste water separate, open scupper valve to discharge all the waste water and be ready for next suction. Pressure can bigger while discharging water. Operation approach as follows:

A, Adjust four-way valve joystick to neutral position, then open the scupper valve to open position, and discharge all the waste water by gravity. **(Recommend)**



Neutral Position

Open Rear Discharging Valve

B, Adjust four-way valve joystick to discharge position, then the vacuum pump keep working, and the pressed air goes into tanker to put waste water quickly out of the tanker. **(Not Recommend)**

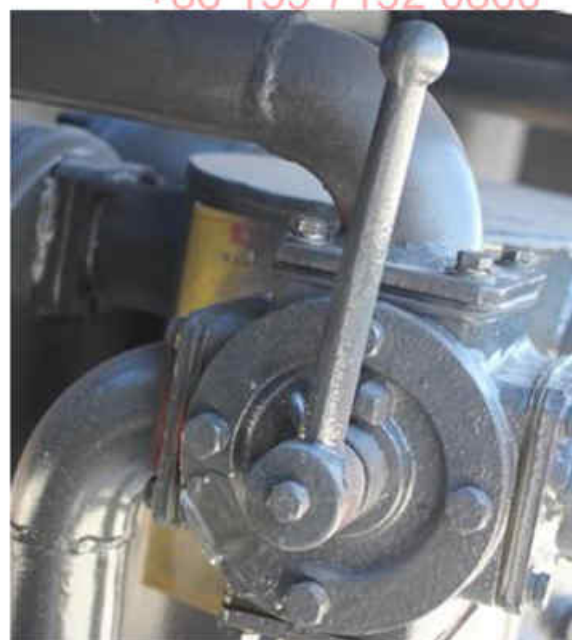

Discharging Position

C, When discharge by pressure, firstly, open the discharge valve, then adjust discharge valve joystick to discharge position, in case of tanker pressure become too high, some accident and bad influence on rear door sealing.

#### 4, Muddy discharge operating instruction

(1) Press the clutch; turn on the PTO switch to make oil pump running.



Pull out the two PTO together  
1. One for Air valve switch  
2. One for Vacuum Pump switch

(2) Rear door clamping device valve to discharge some waste water, and adjust the inside tank pressure to be equal to the outside pressure.



Release the rear door clamping device

Whatsapp: +86 136 4729 9000

(3) Open the rear door clamping device, loosen the handgrip and completely take off screw.

(4) Adjust the rear door manual operated valve to open position, please be sure the inside and outside air pressure is equal before open the door. If the pressure is not equal, the door seal and oil cylinder may be damaged.

LEFT SWITCH  
Push: Open  
Pull: Close



RIGHT SWITCH  
Push: Lifting Up  
Pull: Falling Down



(5) Push manual operated valve joystick to LIFTING UP position

(6) Recovery operation after discharge the sludge: pull manual operated valve joystick to FALLING DOWN position, and carefully exam the follow things after the tanker reposition.

A, Carefully check the tank door flange and seal ring, and clean it if dirty.

B, Adjust manual operated valve joystick to CLOSE position, closes the rear door.

C, Operating the rear door clamping device until the rear door closed completely.



Cleaning Water Tank:  
washing hands or  
some other purpose

Whatsapp: +86 136 4729 9000  
+86 159 7192 0800

## Chapter 5, Troubleshooting

After carefully reading the above information, you must be well known how to use the BEIBEN Vacuum Tanker Truck; below show some important parts to help solve problems.

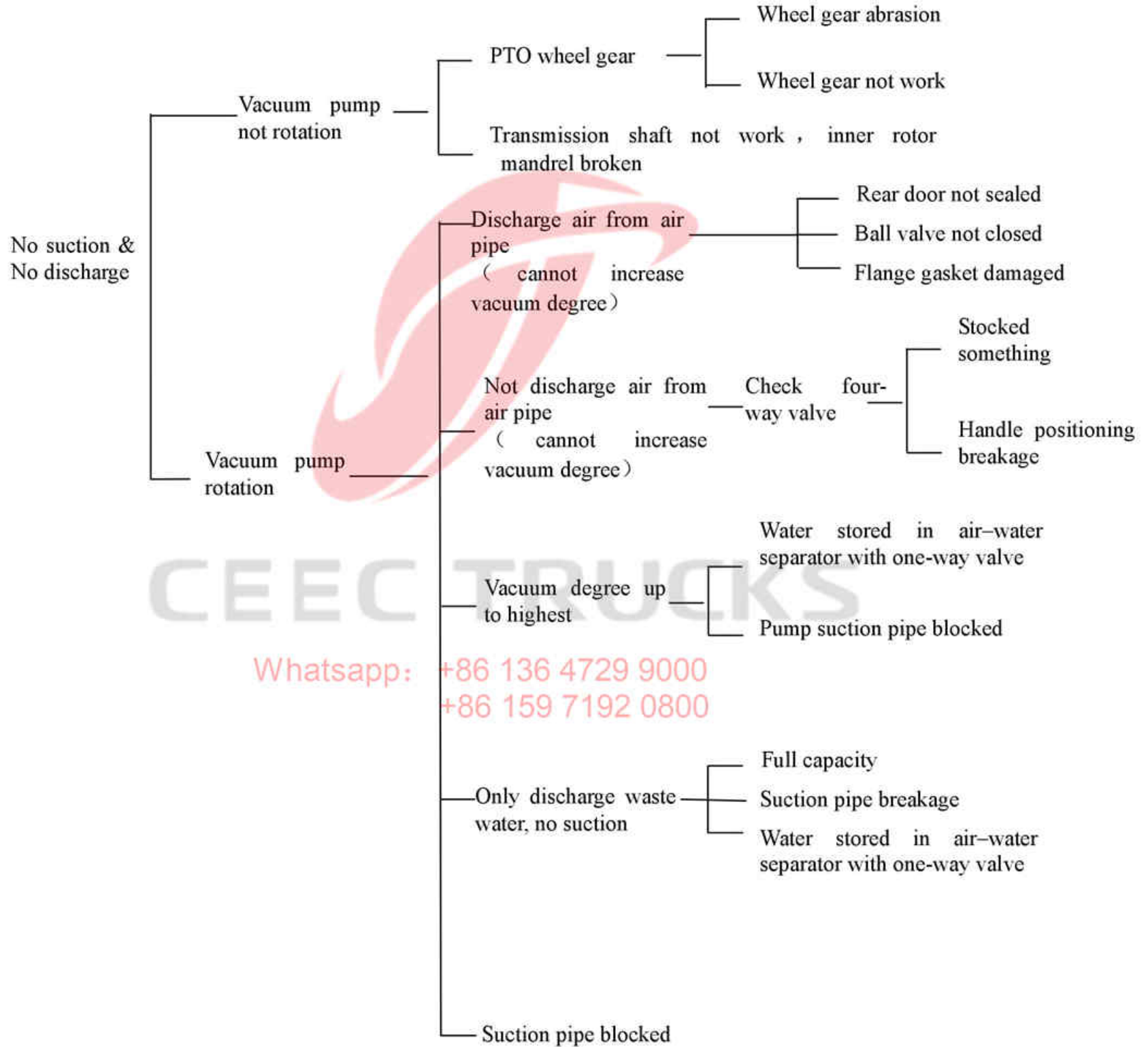

Whatsapp: +86 136 4729 9000  
+86 159 7192 0800